



NOTES:

1. ALL THE LENGTH OF OUTPUT WIRES EXCLUDE HOUSING.
2. Label of origin is marked if indicated by sales.
3. DIMENSIONAL TOLERANCES: .XX=±0.5 [0.02]、.XXX=±0.25 [0.01].
4. Cable used UL2468 black cable(P1~P13、A~O).  
Cable used SOFT軟線 UL1569 black cable(P14~P15).  
(Color of CONNECTOR: Black)

P/N.:9PA750A300

MODEL NO. :FSP750-57AGC,(STD0001)		TITLE:ASSY	SHEET: 1 OF 2	REV:01
R&D 8	PE	DRAWN	DATE	
			AUG.16.2023	
 				

UNIT:mm [inch]

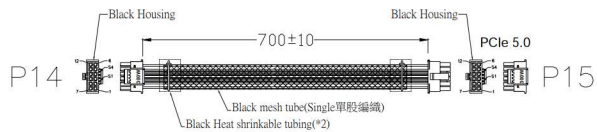
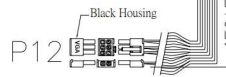
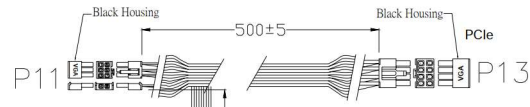
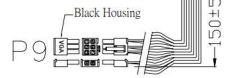
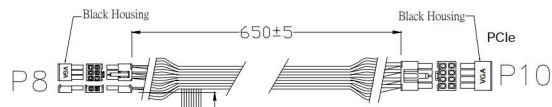
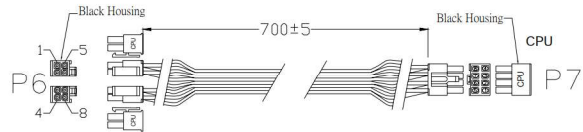
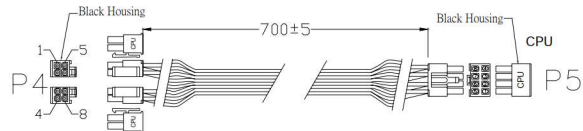
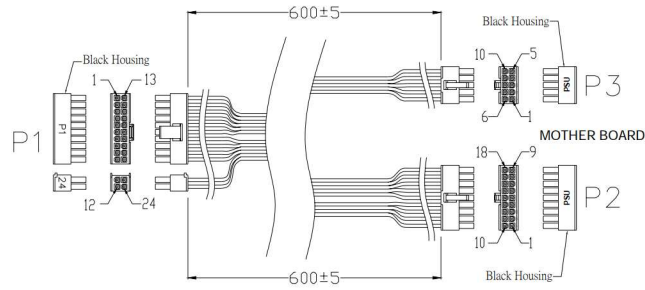

P1 P20-142002K110-B P4-142002K110-B OR ECU.	RATING	WIRE COLOR	WIRE AWG	P2 P18-142002-B3 OR ECU.	P3 P10-142002-B3 OR ECU.
Pin 1	+3.3V	BLACK	18 AWG		Pin 1
Pin 2	+3.3V	BLACK	18 AWG		Pin 2
Pin 3	+3.3V Sense	BLACK	22 AWG	Pin 2	
Pin 4	COM	BLACK	18 AWG	Pin 8	
Pin 5	+5V	BLACK	18 AWG	Pin 5	
Pin 6	COM	BLACK	18 AWG		Pin 5
Pin 7	+5V Sense	BLACK	18 AWG	Pin 6	
Pin 8	COM	BLACK	18 AWG	Pin 3	
Pin 9	PW_OK	BLACK	22 AWG	Pin 10	
Pin 10	+5Vsb	BLACK	18 AWG	Pin 11	
Pin 11	+12V	BLACK	18 AWG		Pin 7
Pin 12	+12V Sense	BLACK	22 AWG	Pin 4	
Pin 13	+12V	BLACK	18 AWG		Pin 8
Pin 14	+3.3V	BLACK	18 AWG		Pin 3
Pin 15	+3.3V	BLACK	18 AWG		Pin 6
Pin 16	+3.3V	BLACK	18 AWG		Pin 9
Pin 17	-12V	BLACK	18 AWG		Pin 9
Pin 18	COM	BLACK	18 AWG	Pin 9	
Pin 19	PS_ON#	BLACK	22 AWG	Pin 1	
Pin 20	COM	BLACK	18 AWG	Pin 12	
Pin 21	COM	BLACK	18 AWG	Pin 16	
Pin 22	COM	BLACK	18 AWG	Pin 17	
Pin 23	+5V	BLACK	18 AWG	Pin 7	
Pin 24	+5V	BLACK	18 AWG	Pin 14	
Pin 25	COM	BLACK	18 AWG	Pin 15	
Pin 26	COM	BLACK	18 AWG	Pin 18	

P4&P6 P4-142002-30-B4 P4-142002-40-B4 OR ECU.	RATING	WIRE COLOR	WIRE AWG	P5&P7 P5-142002-B4 OR ECU.
Pin 1	COM	BLACK	18 AWG	Pin 1
Pin 2	COM	BLACK	18 AWG	Pin 2
Pin 3	COM	BLACK	18 AWG	Pin 3
Pin 4	COM	BLACK	18 AWG	Pin 4
Pin 5	+12V	BLACK	18 AWG	Pin 5
Pin 6	+12V	BLACK	18 AWG	Pin 6
Pin 7	+12V	BLACK	18 AWG	Pin 7
Pin 8	+12V	BLACK	18 AWG	Pin 8

P8&P11 P8-142002K21-B6 P2-142002K130-B OR ECU.	RATING	WIRE COLOR	WIRE AWG	P10&P13 P8-142002K12A-B2 OR ECU.
Pin 1	+12V	BLACK	18 AWG	Pin 1
Pin 2	+12V	BLACK	18 AWG	Pin 2
Pin 3	+12V	BLACK	18 AWG	Pin 3
Pin 4	COM	BLACK	18 AWG	Pin 4
Pin 5	COM	BLACK	18 AWG	Pin 5
Pin 6	COM	BLACK	18 AWG	Pin 6
Pin 7	COM	BLACK	18 AWG	Pin 7
Pin 8	COM	BLACK	18 AWG	Pin 8

P9&P12 P6-142002K21-B6 P2-142002K130-B OR ECU.	RATING	WIRE COLOR	WIRE AWG
Pin 1	+12V	BLACK	18 AWG
Pin 2	+12V	BLACK	18 AWG
Pin 3	+12V	BLACK	18 AWG
Pin 4	COM	BLACK	18 AWG
Pin 5	COM	BLACK	18 AWG
Pin 6	COM	BLACK	18 AWG
Pin 7	COM	BLACK	18 AWG
Pin 8	COM	BLACK	18 AWG

P14 P12-3000P542-B P12-3000P542-B	RATING	WIRE COLOR	WIRE AWG	P15 P12-3000P542-B P12-3000P542-B
Pin 1	+12V	BLACK	18 AWG	Pin 1
Pin 2	+12V	BLACK	18 AWG	Pin 2
Pin 3	+12V	BLACK	18 AWG	Pin 3
Pin 4	+12V	BLACK	18 AWG	Pin 4
Pin 5	+12V	BLACK	18 AWG	Pin 5
Pin 6	+12V	BLACK	18 AWG	Pin 6
Pin 7	COM	BLACK	18 AWG	Pin 7
Pin 8	COM	BLACK	18 AWG	Pin 8
Pin 9	COM	BLACK	18 AWG	Pin 9
Pin 10	COM	BLACK	18 AWG	Pin 10
Pin 11	COM	BLACK	18 AWG	Pin 11
Pin 12	COM	BLACK	18 AWG	Pin 12
Pin S1	CARD_PWR_STABLE	BLACK	28 AWG	Pin S1
Pin S2	CARD_CBL_PRES#	BLACK	28 AWG	Pin S2
Pin S3	SENSE0	BLACK	28 AWG	Pin S3
Pin S4	SENSE1	BLACK	28 AWG	Pin S4

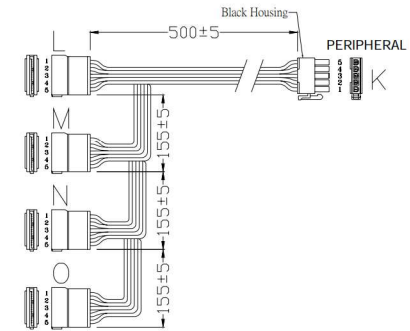
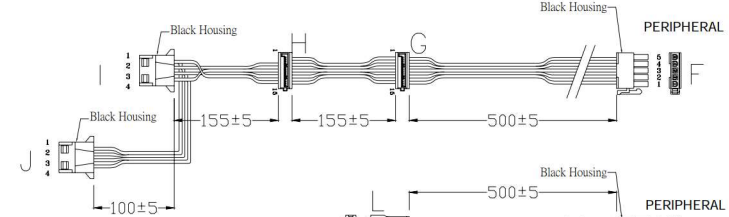
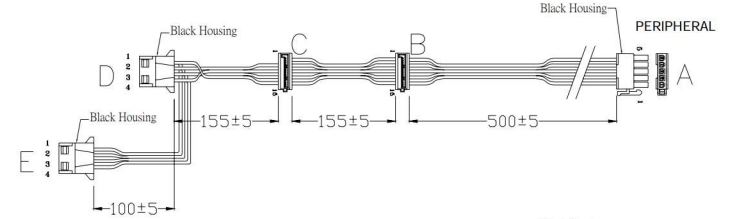

B&G P5-112702T00 P5-112702C OR ECU.	RATING	WIRE COLOR	WIRE AWG	A&F J2416V2-151A-0 OR ECUV.
Pin 1	+3.3V	BLACK	18 AWG	Pin 5
Pin 2	COM	BLACK	18 AWG	Pin 4
Pin 3	+5V	BLACK	18 AWG	Pin 3
Pin 4	COM	BLACK	18 AWG	Pin 2
Pin 5	+12V	BLACK	18 AWG	Pin 1

L SD-67582-001 OR ECU.	RATING	WIRE COLOR	WIRE AWG	K J2416V2-151A-0 OR ECUV.
Pin 1	+3.3V	BLACK	18 AWG	Pin 5
Pin 2	COM	BLACK	18 AWG	Pin 4
Pin 3	+5V	BLACK	18 AWG	Pin 3
Pin 4	COM	BLACK	18 AWG	Pin 2
Pin 5	+12V	BLACK	18 AWG	Pin 1

M&N&O SD-67582-001 OR ECU.	RATING	WIRE COLOR	WIRE AWG
Pin 1	+3.3V	BLACK	18 AWG
Pin 2	COM	BLACK	18 AWG
Pin 3	+5V	BLACK	18 AWG
Pin 4	COM	BLACK	18 AWG
Pin 5	+12V	BLACK	18 AWG

UNIT:mm [inch]

**P/N.:9PA750A300**

MODEL NO. :FSP750-57AGC,(STD0001)

TITLE:ASSY

SHEET: 2 OF 2 REV:01