

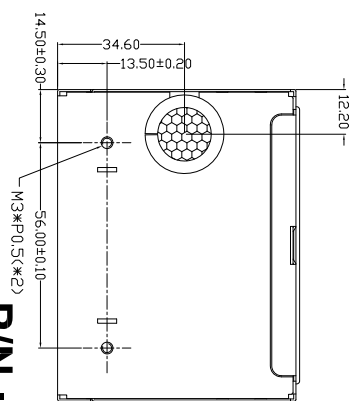

FSP GROUP

全漢企業股份有限公司
FSP TECHNOLOGY INC.

REF. ID.	PIN NO.	SIGNAL	WIRE COLOR	WIRE GAUGE	CONNECTOR TYPE	CABLE LENGTH
P1	1	+3.3VDC	ORANGE	18	MOLEX 39-01-	180±30mm
	2	+5VDC	BLACK	18	22240	-10
	3	COM	RED	18	or EQUIV.	
	4	+5VDC	RED	18		
	5	COM	BLACK	18		
	6	+5VDC	RED	18		
	7	COM	BLACK	18		
	8	PM-OK	GRAY	24		
	9	+5VSB	PURPLE	20		
	10	+12V	YELLOW	18		
	11	+12V	YELLOW	18		
	12	+3.3VDC	ORANGE	18		
	13	+3.3VDC	ORANGE	18		
	14	PS-ON	BROWN	24		
	15	COM	BLACK	18		
	16	PS-ON	GREEN	24		
	17	COM	BLACK	18		
	18	COM	BLACK	18		
	19	COM	BLACK	18		
	20	COM	BLACK	18		
	21	+5VDC	RED	18		
	22	+5VDC	RED	18		
	23	+5VDC	RED	18		
	24	COM	YELLOW	18	AMP	280±30mm
PA	1	+12V1	YELLOW	18	-480424-0	-10
	2	COM	BLACK	18	or EQUIV.	
	3	+5V	RED	18		
PB	1	+12V1	YELLOW	22	AMP	150±10mm
	2	COM	BLACK	22	1771707-4	or EQUIV.
	3	COM	BLACK	22		
PC	1	+12V1	YELLOW	20	AMP	150±10mm
	2	COM	BLACK	20	-480424-0	or EQUIV.
	3	+5V	RED	20		
	4	+5V	RED	20		
PD	1	COM	BLACK	18	MOLEX	280±30mm
	2	COM	BLACK	18	SP-67968-001	-10
	3	+5V	RED	18	or EQUIV.	
	4	COM	YELLOW	18		
	5	+12V	YELLOW	18		
PE	1	COM	BLACK	18	MOLEX	330±30mm
	2	+12V2	YEL/BLK	18	39-01-2040	or EQUIV.
	3	+5V	RED	18		
	4	+12V2	YEL/BLK	18		
PF	1	COM	BLACK	18	MOLEX	280±30mm
	2	COM	BLACK	18	SP-67968-001	-10
	3	+5V	RED	18	or EQUIV.	
	4	COM	YELLOW	18		
PG	1	COM	BLACK	20	MOLEX	150±10mm
	2	COM	BLACK	20	SP-67968-001	or EQUIV.
	3	+5V	RED	20		
	4	COM	BLACK	20		
	5	+12V	YELLOW	20		

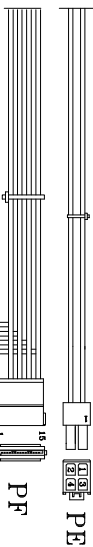
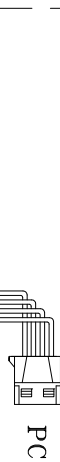
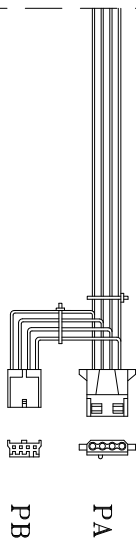
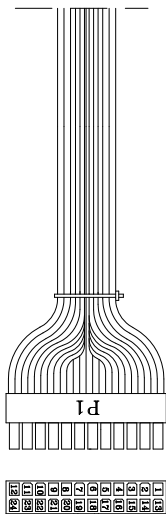
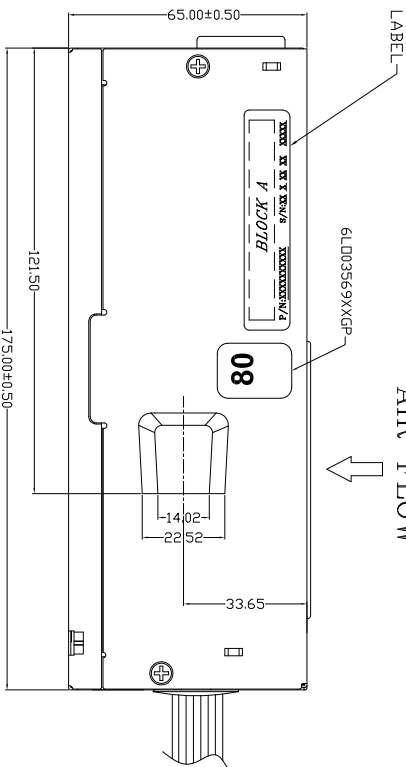
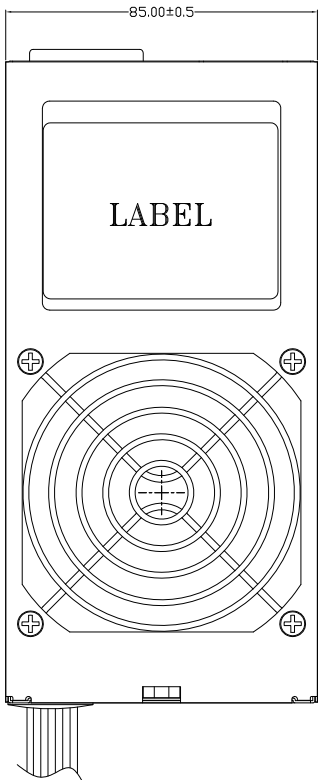
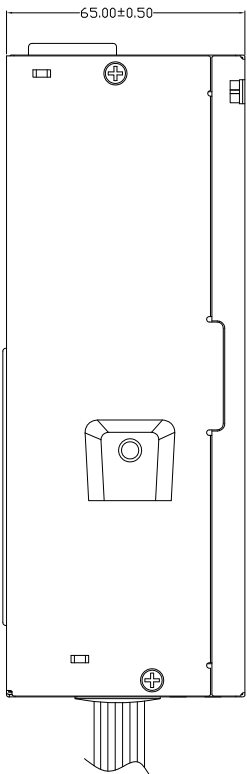
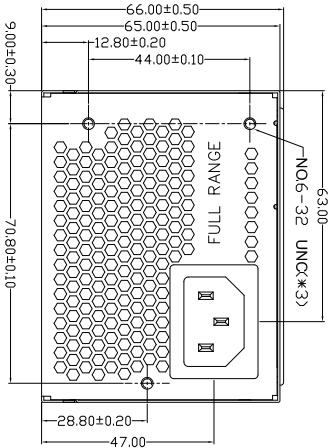

P/N.:9PA250DZ00

UNIT:mm

MODEL NO. : FSP250-60SGV		TITLE:ASSY	
R&D(1)	PE	DRAWN	DATE
		SEP.06.2012	
		SHEET: 1DF 1	REV:01

Mechanical Drawing(外觀/機構圖)表單編號7000P-0111